

Solo com capacidade de suporte > 1.50 kgf/cm²
Solo compactado sobre a sapata
peso específico > 1600.00 kgf/m³

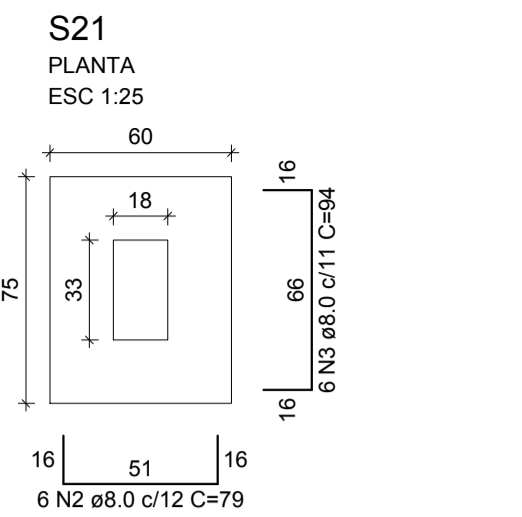

Solo com capacidade de suporte > 1.50 kgf/cm²
Solo compactado sobre a sapata
peso específico > 1600.00 kgf/m³

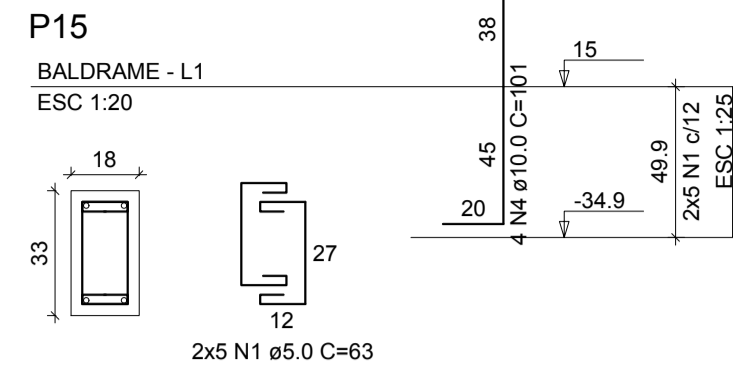
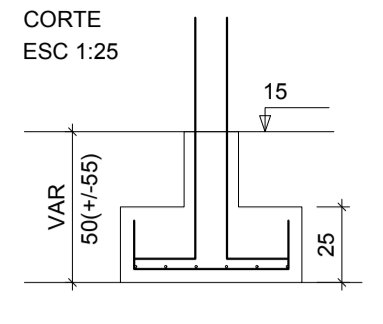
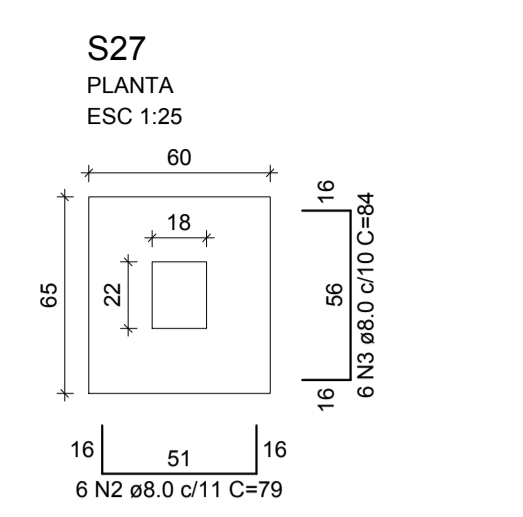
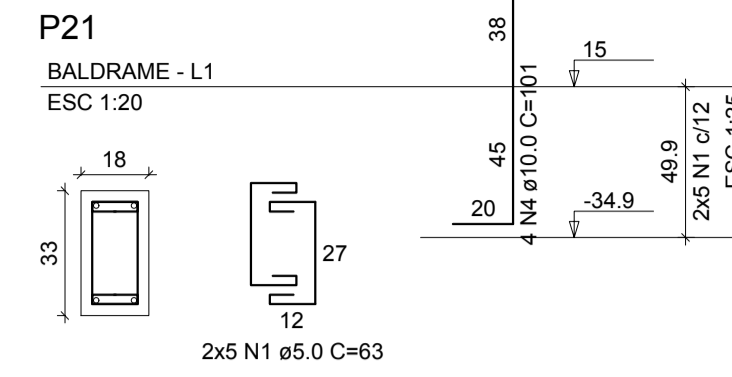
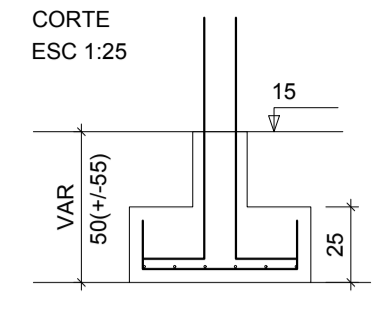

Solo com capacidade de suporte > 1.50 kgf/cm²
Solo compactado sobre a sapata
peso específico > 1600.00 kgf/m³

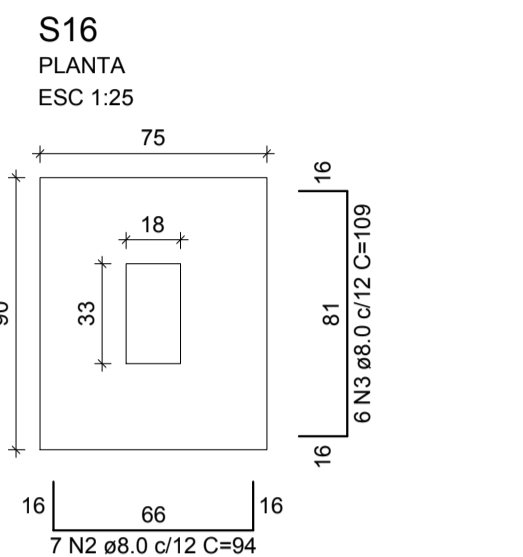
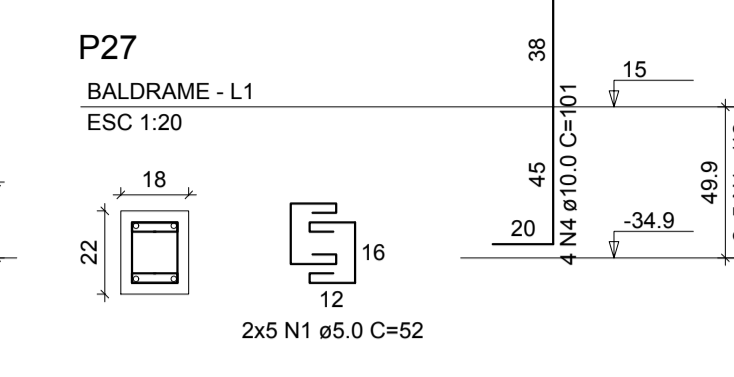
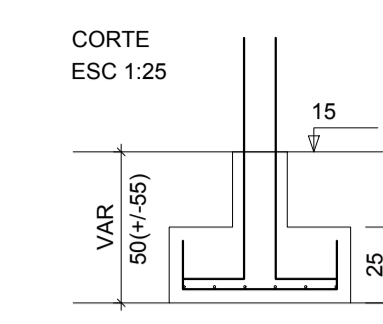

Solo com capacidade de suporte > 1.50 kgf/cm²
Solo compactado sobre a sapata
peso específico > 1600.00 kgf/m³

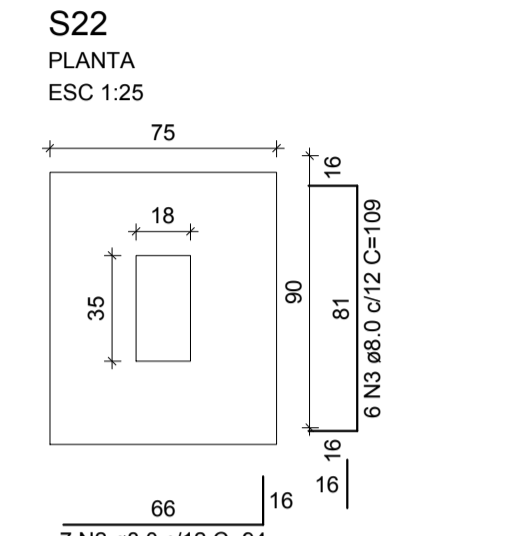
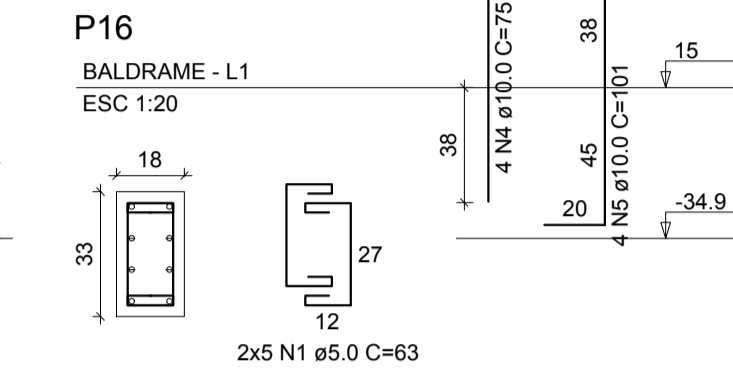
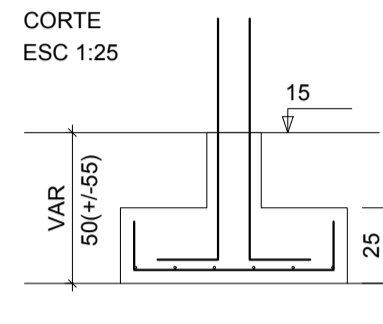

Solo com capacidade de suporte > 1.50 kgf/cm²
Solo compactado sobre a sapata
peso específico > 1600.00 kgf/m³

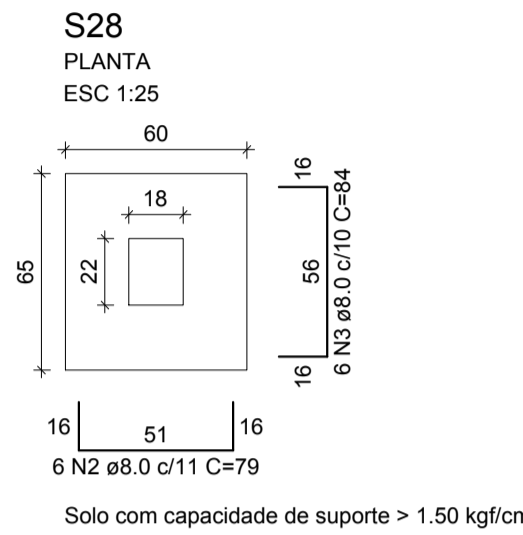
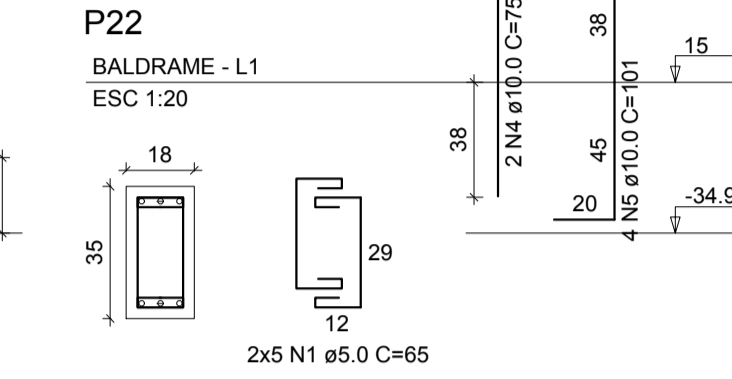
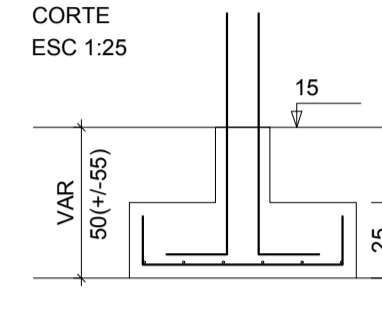

Solo com capacidade de suporte > 1.50 kgf/cm²
Solo compactado sobre a sapata
peso específico > 1600.00 kgf/m³

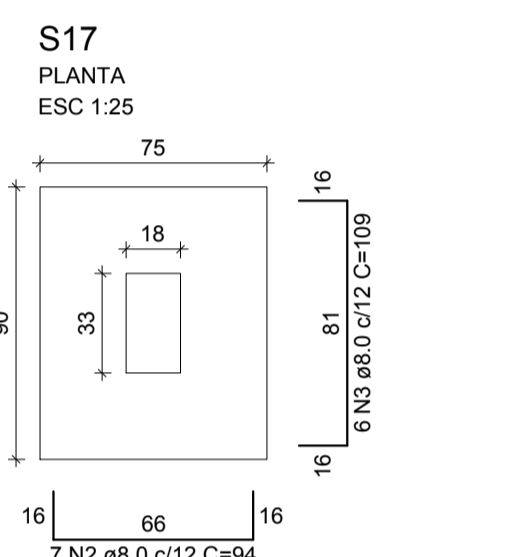
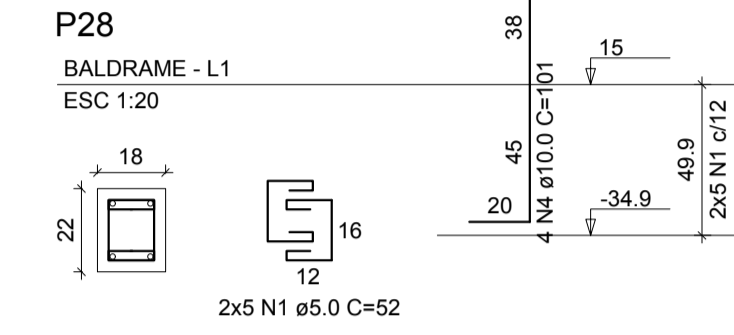
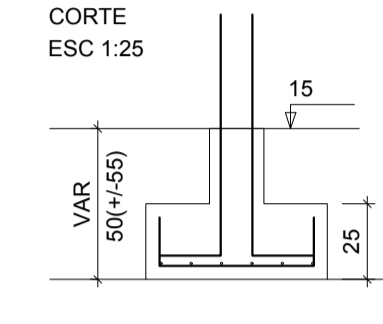

Solo com capacidade de suporte > 1.50 kgf/cm²
Solo compactado sobre a sapata
peso específico > 1600.00 kgf/m³

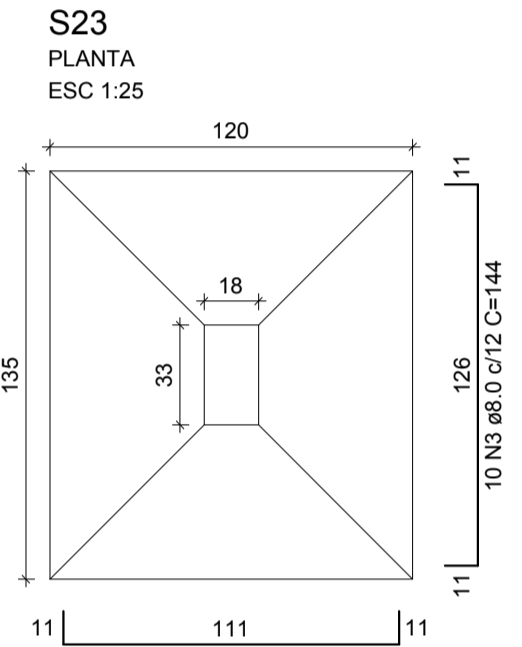
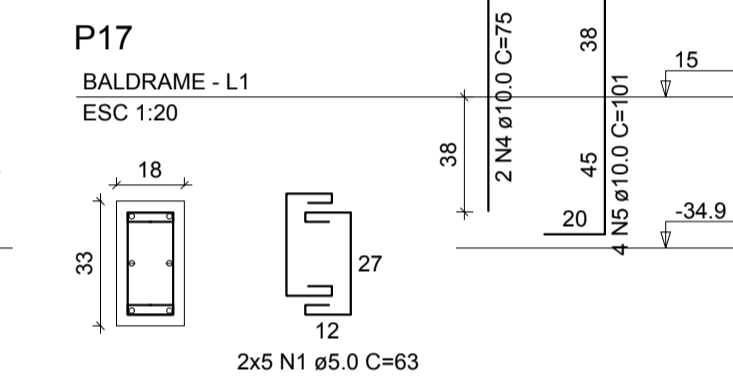
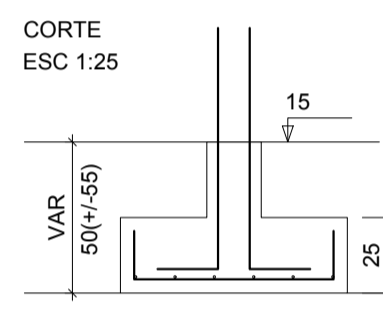

Solo com capacidade de suporte > 1.50 kgf/cm²
Solo compactado sobre a sapata
peso específico > 1600.00 kgf/m³

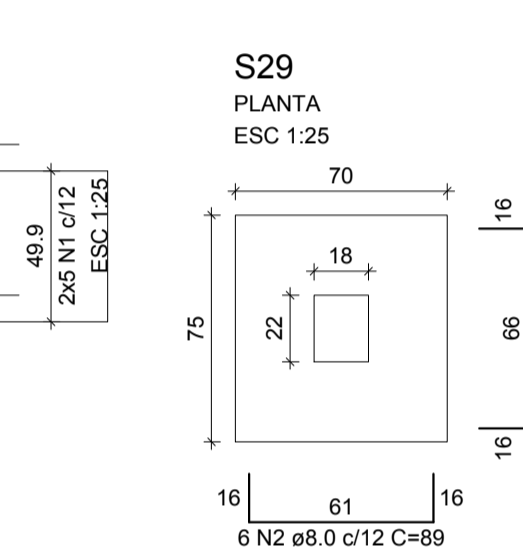
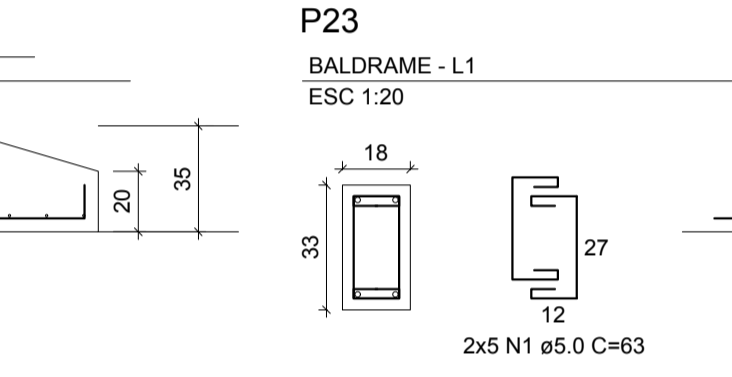
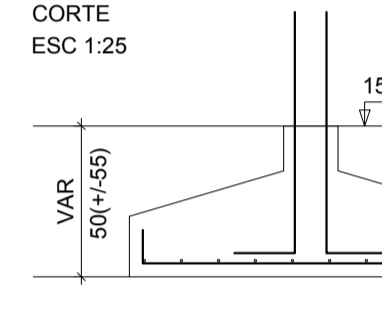

Solo com capacidade de suporte > 1.50 kgf/cm²
Solo compactado sobre a sapata
peso específico > 1600.00 kgf/m³

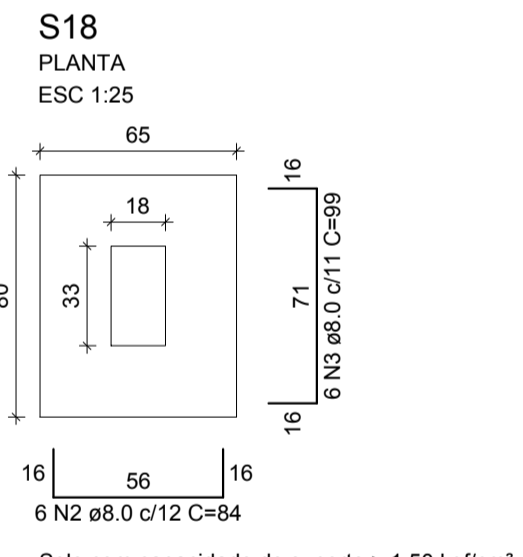
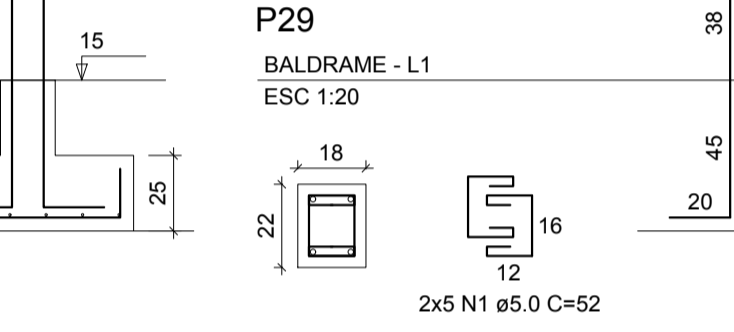
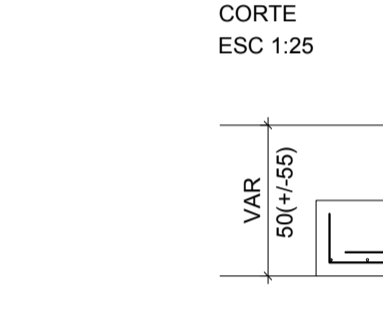

Solo com capacidade de suporte > 1.50 kgf/cm²
Solo compactado sobre a sapata
peso específico > 1600.00 kgf/m³

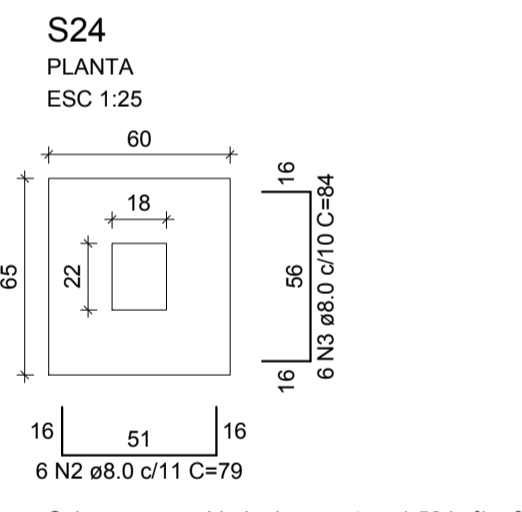
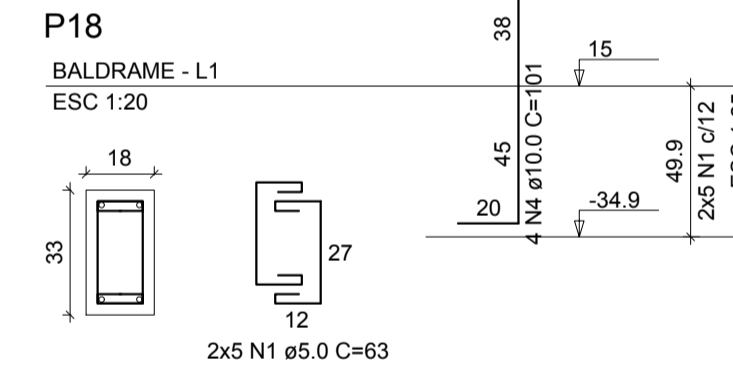
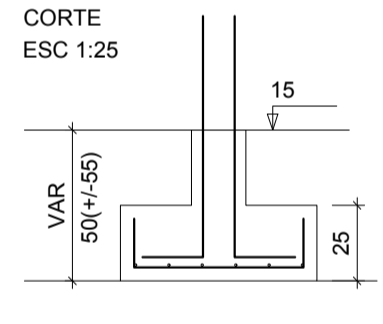

Solo com capacidade de suporte > 1.50 kgf/cm²
Solo compactado sobre a sapata
peso específico > 1600.00 kgf/m³

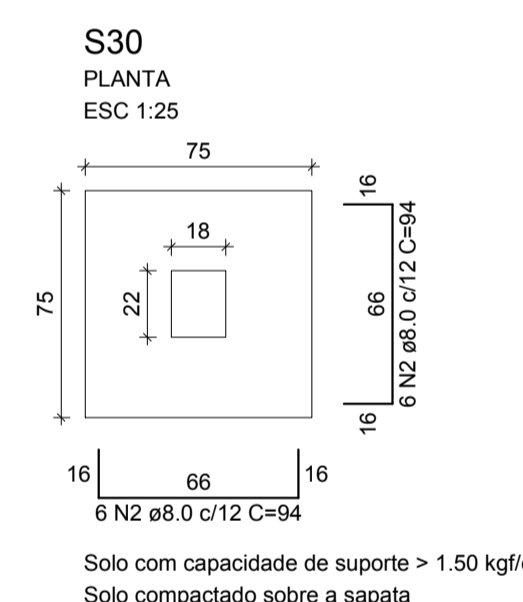
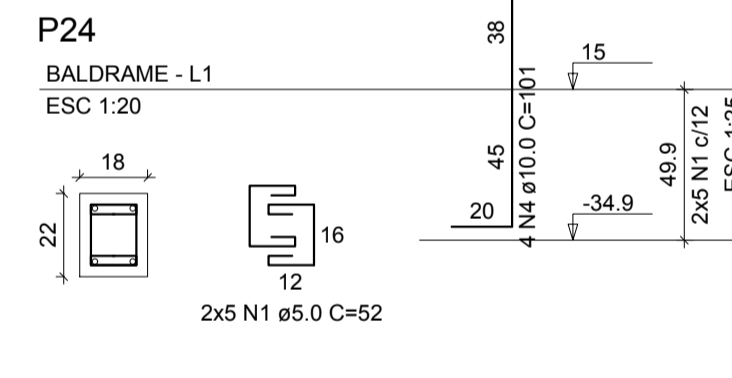
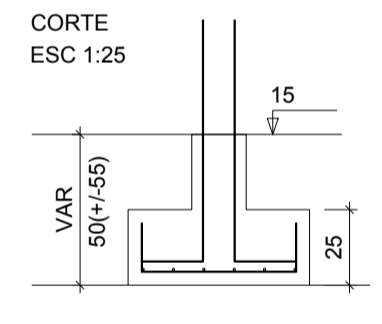

Solo com capacidade de suporte > 1.50 kgf/cm²
Solo compactado sobre a sapata
peso específico > 1600.00 kgf/m³

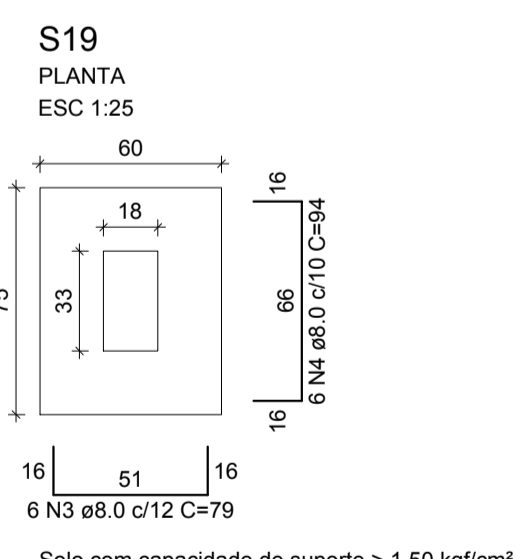
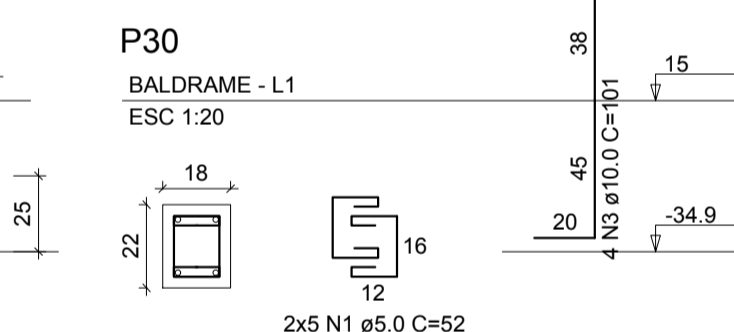
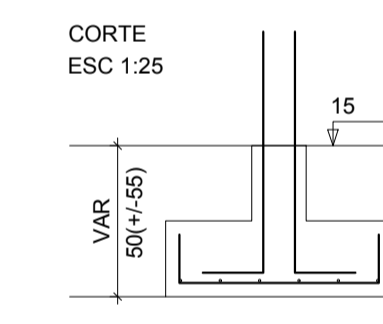

Solo com capacidade de suporte > 1.50 kgf/cm²
Solo compactado sobre a sapata
peso específico > 1600.00 kgf/m³

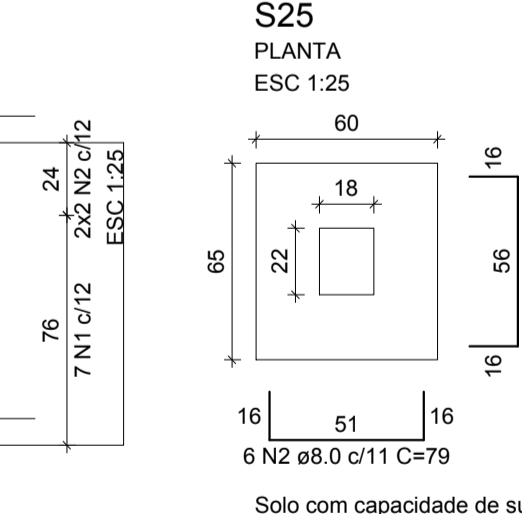
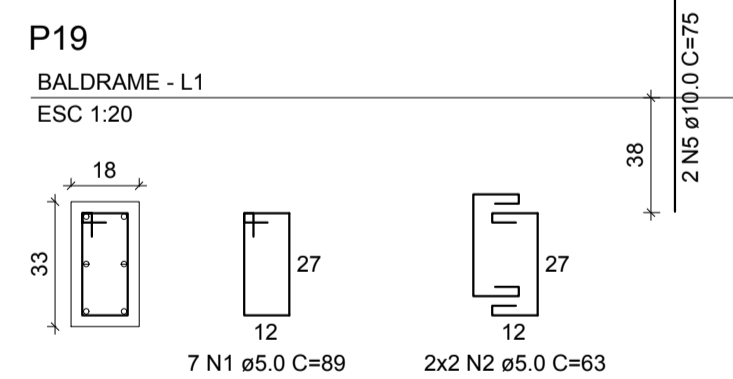
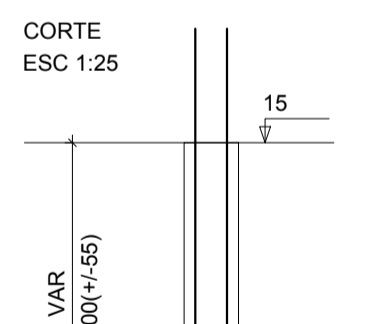

Solo com capacidade de suporte > 1.50 kgf/cm²
Solo compactado sobre a sapata
peso específico > 1600.00 kgf/m³

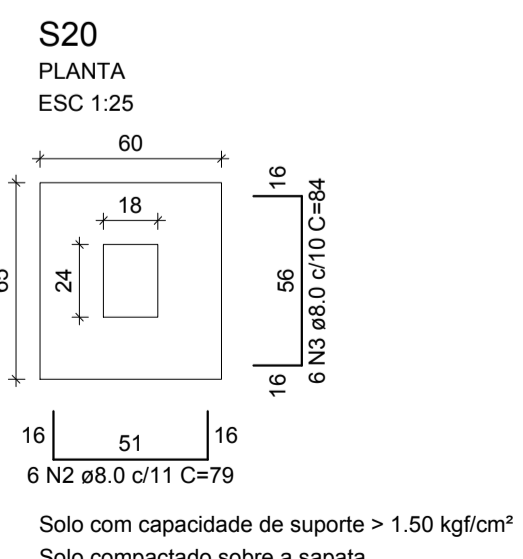
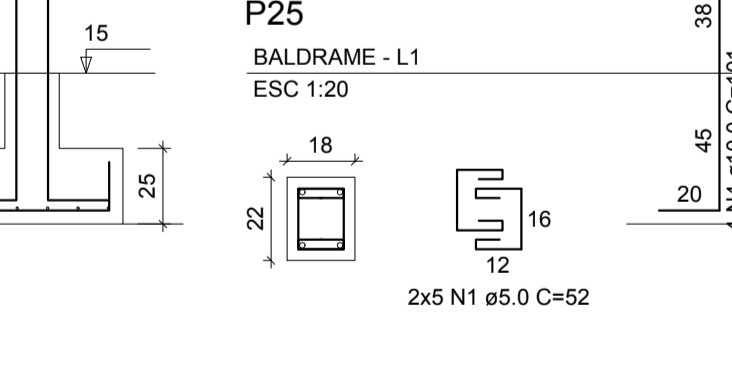
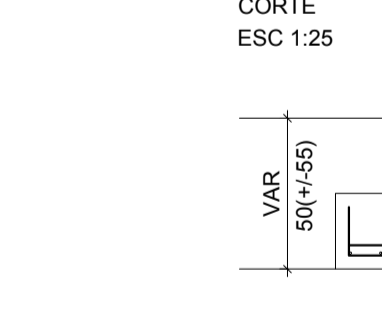

Solo com capacidade de suporte > 1.50 kgf/cm²
Solo compactado sobre a sapata
peso específico > 1600.00 kgf/m³

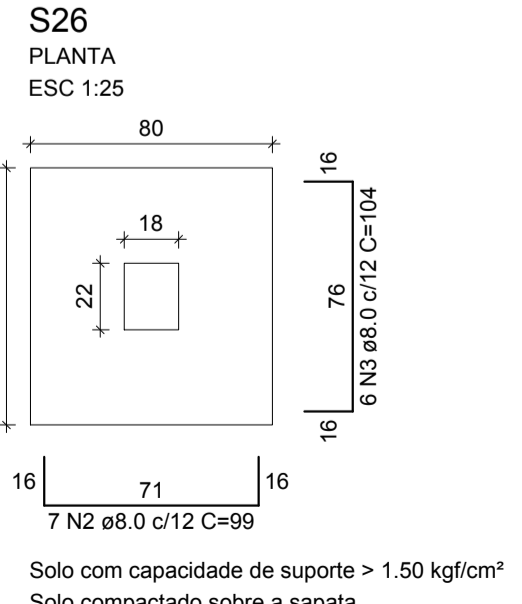
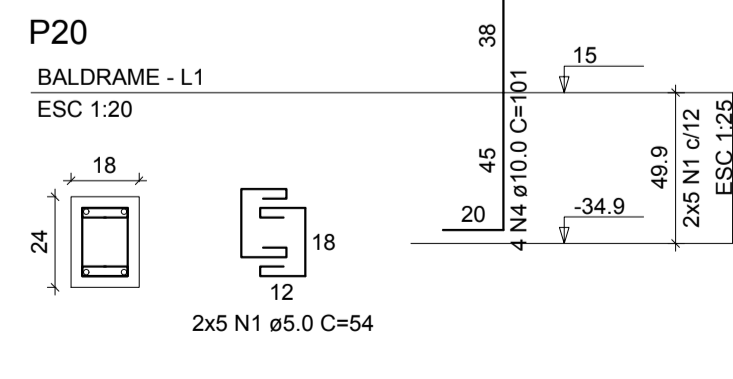
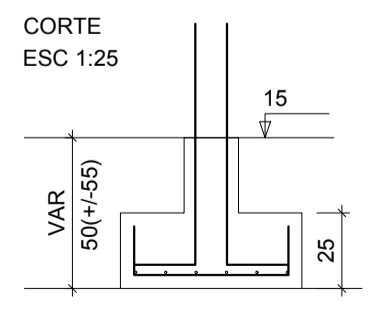

Solo com capacidade de suporte > 1.50 kgf/cm²
Solo compactado sobre a sapata
peso específico > 1600.00 kgf/m³

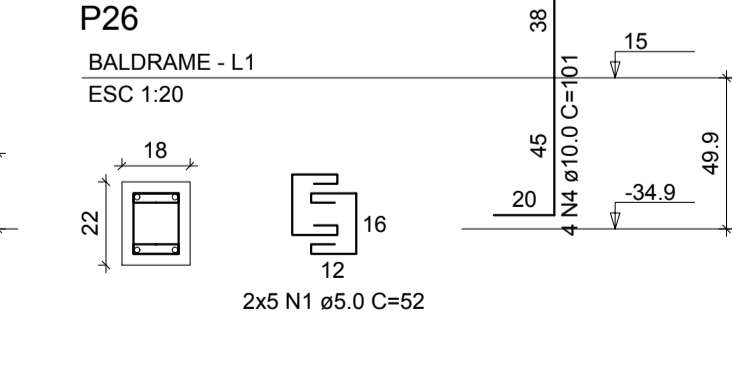
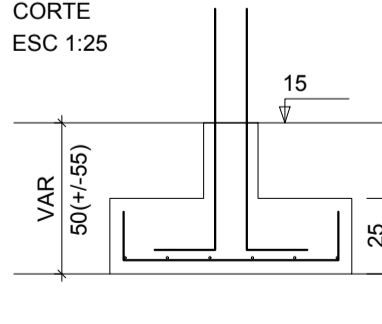

HERGYA APARECIDA KELLER ENGENHEIRA CIVIL CREA-RS 219763		PROPRIETARIO(A): PREFEITURA MUNICIPAL DE SALDANHA MARINHO CNPJ: 92.399.153/0001-71	
TIPO	PROJETO DE EDIFICAÇÃO CENTRO DE CONVIVÊNCIA		
DESIGNAÇÃO	PROJETO ESTRUTURAL - SAPATAS		
ENDEREÇO	RUA GOMERCINDO SARAIVA ESQ. CAP. AUG. HELMEL (S=01, Q=09, L=315)		
LOCAL	SALDANHA MARINHO - RS		
DATA	AGOSTO/2020	HERGYA APARECIDA KELLER	PREF. MUN. DE SALDANHA MARINHO
		ESCALA INDICADA	
		10	